

CN0140 & CN0150 SERIES

STEP MOTOR DRIVES OPERATING MANUAL

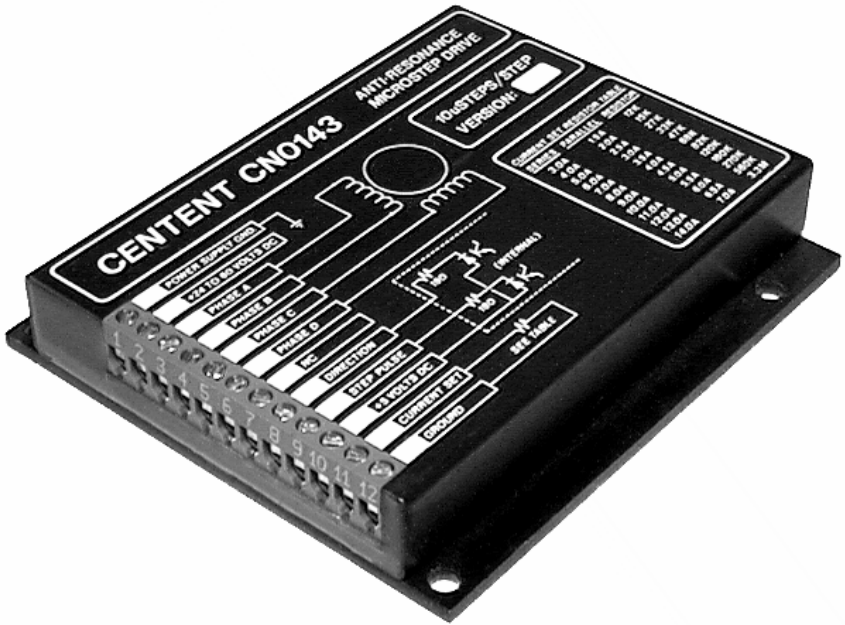

3879 SOUTH MAIN STREET 714-979-6491
 SANTA ANA, CALIFORNIA 92707-5710 U.S.A.

This manual contains information for installing and operating the following Centent Company products:

- CN0142 & CN0143 Microstep Drives
- CN0152 & CN0153 Full / Half-Step Drives

Centent and the Centent Company logo are trademarks of Centent Company. Other trademarks, tradenames, and service marks owned or registered by any other company and used in this manual are the property of their respective companies.

Copyright © 2011 Centent Company
3879 South Main Street
Santa Ana, CA 97207
All Rights Reserved

CONTENTS

General Description	1
Connector Description	3
Power Supply Requirements	3
Fuse	3
Motor Output	4
Motor Wiring	5
Series Wired	5
Parallel Wired	5
Motor Wire Color Codes	6
Noise Precautions	7
N/C (142A/3A), Anti-Resonance Disable (142B/3B), Full/Half-Step Select (152/3)	7
Direction and Step Inputs	8
Default Current	8
Standby Implementation	10
Microstepping	11
Factors Affecting Microstep Accuracy	12
Motor Accuracy	12
Motor Linearity	12
Motor Load	13
Anti-Resonance Circuit	13
Disadvantages	15
Performance Considerations	16
Torque and Power vs. Speed	16
Factors Affecting Power and Torque	17
Power Supply Voltage	17
Series vs. Parallel Operations	18
Torque	19
Power Supply Current	20
Heating Considerations	21
Motor Speed-Torque and Speed Power Curves	22
Specifications	37

GENERAL DESCRIPTION:

The Centent CN0142 and CN0143 are step motor drives whose major features are microstepping and anti-resonance circuitry. These compensate for low speed vibration and mid-band instability respectively. The CN0152 and CN0153 are full/half step versions of these microstep drives and share much of the same circuitry. The CN0142 is designed to run unipolar hybrid PM step motors with current ratings from .75 to 7 amps per phase; the CN0143 is designed to work with motors rated at 1.5 to 14 amps per phase; the CN0152 with motors from .25 to 7 amps per phase; and the CN0153 with motors from .5 to 14 amps per phase.

The control interface for these drives is opto-isolated for maximum noise immunity. The inputs are directly compatible with TTL drivers and do not require additional components.

The drives require a single voltage, unregulated DC power supply between 24 VDC and 60 VDC. The power supply current requirements are very modest. For 6 wire step motors wired in the series configuration, the power supply current is approximately 1/3 of the motor's rated per phase current.

A high efficiency switching 'H' bridge output utilizes power MOSFETS to keep heating to a minimum. Under most conditions the drives will not require heat sinking. It is sufficient to bolt them down to a metal chassis in the user's system.

The drives are small; measuring 4" x 4.5" x .8" and weighing only 1.2 lb. They come encapsulated in a heat conductive epoxy and encased in an anodized aluminum outer cover. The result is a compact environmentally rugged package that resists abuse that would destroy most other controls.

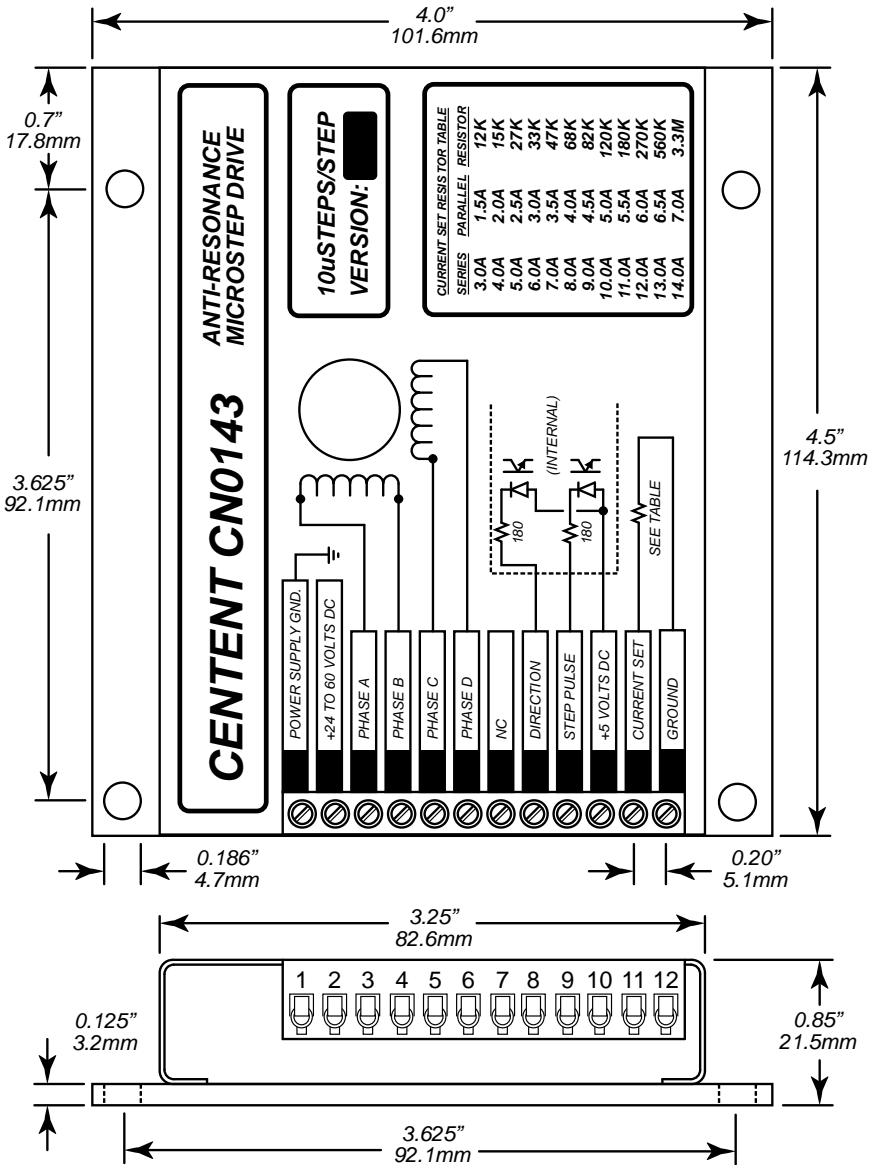

CONNECTOR DESCRIPTION:

TERMINAL 1,2 POWER SUPPLY

Terminal 1 (internally connected to Terminal 12) is the power supply return or ground connection. Terminal 2 is the positive power supply input connection. The power supply voltage range is from 24 VDC to 60 VDC. The power supply need not be regulated; however if an unregulated power supply is used, care must be taken to insure that the power supply ripple and line voltage tolerance do not exceed this specified supply voltage range. The recommended power supply ripple voltage is 1 volt peak to peak or less for best performance.

Power supply current may be estimated for a 6 wire motor as 1/3 of the motor's per phase current rating for series operation (fig. 3). For parallel operation (fig. 4), use 2/3 of motor's per phase current rating for estimating supply current. At light loads and medium speeds considerably less current is needed.

See 'PERFORMANCE CONSIDERATIONS' (page 16) for more information about the selection of an appropriate power supply voltage and motor operating mode.

WARNING!

ALWAYS DISCONNECT POWER TO THE DRIVE BEFORE EITHER CONNECTING OR DISCONNECTING ANY MOTOR LEADS. FAILURE TO DO THIS WILL RESULT IN IRREPARABLE DAMAGE TO THE DRIVE.

During rapid deceleration of large inertial loads, step motors generate considerable power. This power is returned to the power supply by the step motor drive. Usually the filter capacitor in the power supply is sufficient to absorb this power safely and keep the voltage rise to acceptable limits. If the power supply cannot absorb this power, the voltage generated may exceed the 60 VDC limit of the drive. Damage may result to the control, power supply, or both. In this rare instance, an external voltage clamp, such as a 68 volt zener diode, is recommended as protection.

For protection against motor to ground shorts, power supply voltage reversal and other anomalies, use a 5 AMP fuse from the power supply to TERMINAL 2.

Example: Design an unregulated power supply for use with a SUPERIOR ELECTRIC M092 FD04. Series operation at 35 VDC will be used.

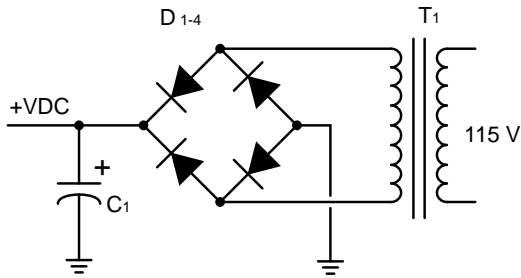

Figure 1

1. The M092 FD04 has a current rating of 4 Amps per phase. Because series operation is to be used, power supply current will not exceed:

$$I_{\text{supply}} = I_M / 3 = 4 / 3 = 1.33 \text{ AMPS}$$

2. For a ripple voltage of 1 volt or less, the minimum capacitor (C1) size is:

$$C1 = I_{\text{supply}} \times 8333 = 1.33 \times 8333 = 11,000 \text{ MFD}$$

3. The transformer (T1) secondary voltage is going to be:
 $V_{\text{RMS}} = V_{\text{supply}} \times .7071 = 35 \times .7071 = 25 \text{ VAC}$

The secondary current rating should be at least 1.5 AMPS.

TERMINAL 3,4,5,6 MOTOR OUTPUT

One motor winding connects to terminals 3 and 4, while the other winding connects to terminals 5 and 6. The step motor drive will operate 4,6 and 8 wire motors. The 6 and 8 wire motors may be wired in either a series or parallel configuration. For 8 wire motors, follow the manufacturer's hook-up diagrams for series or parallel operation.

WARNING!

BEFORE EITHER CONNECTING OR DISCONNECTING ANY MOTOR LEADS, ALWAYS DISCONNECT THE POWER FIRST. IF THIS IS NOT DONE, THE DRIVE WILL BE PERMANENTLY DAMAGED.

The most common step motor has 6 lead wires, which connect to a pair of center-tapped windings. A typical 6 wire motor is shown below (fig. 2). The SUPERIOR ELECTRIC color code is used in this example.

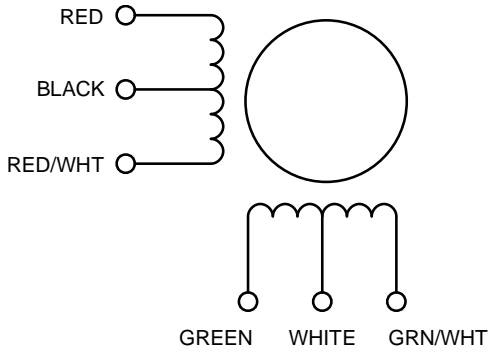

Figure 2 - Motor Wiring

SERIES WIRED

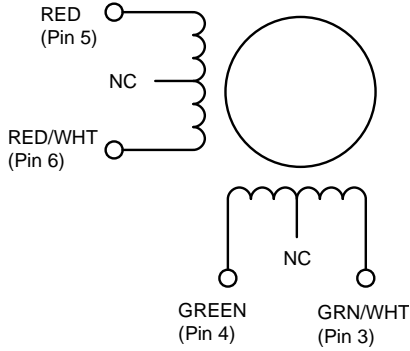

Figure 3 - Series Wired

PARALLEL WIRED

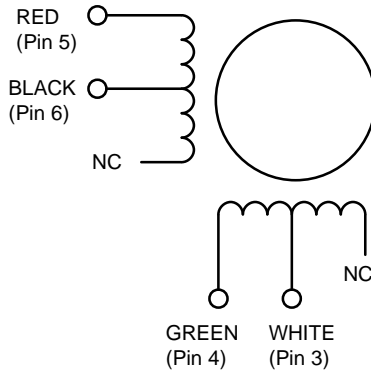

Figure 4 - Parallel Wired

Parallel wired step motors have twice the peak shaft power as series wired step motors. Parallel wired step motors also have more than twice as much heat dissipation as do series wired motors. For a more thorough discussion see the 'PERFORMANCE CONSIDERATIONS' section starting on page 16.

When using the series configuration, select the appropriate current set resistor from the CURRENT SET RESISTOR TABLE. When using the parallel configuration, or a 4 wire motor, make the selection from the 'PARALLEL' column.

The proper motor wire color code to drive connector hook-up for series and parallel operation is shown in the tables below. This hook-up will yield clockwise motor rotation when the DIRECTION input is at a logical '0'.

Table 1 SERIES WIRED

Manufacturer	T 3	T 4	T 5	T 6
Superior Electric	Grn/Wht	Green	Red	Red/Wht
Rapidsyn	Grn/Wht	Green	Red	Red/Wht
Imc	Grn/Wht	Green	Red	Red/Wht
Sigma	Yellow	Red	Black	Orange
Oriental Motor	Blue	Red	Black	Green
Portescap	Yel/Wht	Red	Org/wht	Brown
Bodine	Yellow	Red	Brown	Orange
Digital Motor	Yellow	Red	Black	Orange
Warner	Red	Yellow	Orange	Brown
Japan Servo	Yellow	Green	Blue	Red

TABLE 2 PARALLEL WIRED

Manufacturer	T 3	T 4	T 5	T 6
Superior Electric	White	Green	Red	Black
Rapidsyn	White	Green	Red	Black
Imc	White	Green	Red	Black
Sigma	Red/Yel	Red	Org/Blk	Orange
Oriental Motor	Blue	White	Yellow	Green
Portescap	Yel/Wht	Red	Org/wht	Brown
Bodine	Red/Wht	Red	Org/wht	Orange
Digital Motor	Red/Wht	Red	Black	Blk/Wht
Warner	Red	White	Orange	Black
Japan Servo	White	Green	Blue	White

Under some conditions the unused wires may have voltages in excess of 120 volts. Consequently all motor wires not used should be insulated and not allowed to touch anything.

The CN0142/CN0143 and CN0152/CN0153 are high frequency switching type drives. Because of the power involved and the rapid rate of current and voltage change inherent in this type of control, considerable RFI is generated. The following precautions must be taken to prevent this noise from coupling back to the inputs and causing erratic operation.

1. Never bundle the motor leads in the same cable as the STEP and DIRECTION input leads.
2. Always keep power supply leads as short as possible. If this is impractical, use .1 MFD and 100 MFD capacitors directly across TERMINALS 1 and 2 at the step motor drive.
3. Never wire capacitors, inductors or any other components to the motor output terminals.
4. Always ground the chassis that the step motor drive is mounted on.
5. Always ground the motor case.
6. Never use op amps, optocouplers or other slow transitioning devices to drive the STEP input. Keep the logic transitions to 200 nSec. or less.

**TERMINAL 7 NO CONNECTION (CN0142A / CN0143A)
ANTI-RESONANCE DISABLE (CN0142B /
CN0143B)
FULL/HALF STEP SELECT (CN0152 / CN0153)**

On the CN0142A/CN0143A microstep drives this terminal is reserved for future use. Do not connect.

On the CN0142B/CN0143B microstep drives, this terminal is used to select between anti-resonance enable and disable. If the terminal is left unconnected, the control will operate with anti-resonance enabled; if it is shorted to ground, anti-resonance will be disabled.

On the CN0152/CN0153 full and half step drives this terminal is used to select between full and half step operation. If the terminal is left unconnected, the control will operate as a full step drive; if it is shorted to ground, the control will function as a half step drive.

TERMINAL 8,9,10 DIRECTION AND STEP INPUTS

Terminal 8 is 'DIRECTION' input. A low level on this terminal will result in a clockwise microstep when the 'STEP' input is pulsed on a CN0142 or CN0143 microstep drive. The same input on a CN0152/CN0153 will result in either a full or half step (depending on Terminal 7 setting) being taken in the same direction. Terminal 9 is the 'STEP' input. A step occurs on the high to low transition of the 'STEP' input, the direction being set by the level on the 'DIRECTION' input at that moment. Terminal 10 is the '+5 VOLT' common to terminal 8 and 9.

The DIRECTION and STEP inputs are optically isolated from the rest of the step motor drive circuitry. The isolated inputs are intended to be driven directly by standard TTL or open collector outputs. Because TTL is current sink logic, the driver 5 VDC power supply must be connected to terminal 10, '+5 VOLT'.

Both the DIRECTION and STEP inputs require 16 mA current sink capability. The logic transition time for the STEP input must be 200 nanoseconds or less. The minimum pulse width for the STEP input is 1 microsecond. The maximum pulse rate is 1 Mhz when a 50% duty cycle square wave is used.

TERMINAL 11,12 CURRENT SET

The primary function of the CURRENT SET terminal is to set the magnitude of the motor phase currents. This is done by connecting a 1/4 watt resistor between terminals 11 and 12. The correct resistor value in ohms is chosen from the tables below. For convenience the appropriate table is also printed on the face of the step motor drive. If a 6 wire motor is to be series connected, use the first column, otherwise use the second column for parallel connected motors.

Match the motor's per phase current to the closest listed table entry, then pick the resistor associated with that current.

TABLE 3**CN0142 & CN0152 CURRENT SET RESISTOR TABLE**

SERIES	PARALLEL	RESISTOR
1.5A	.75A	12K
2.0A	1.00A	15K
2.5A	1.25A	27K
3.0A	1.50A	33K
3.5A	1.75A	47K
4.0A	2.00A	68K
4.5A	2.25A	82K
5.0A	2.50A	120K
5.5A	2.75A	180K
6.0A	3.00A	270K
6.5A	3.25A	560K
7.0A	3.50A	3.3M

TABLE 4**CN0143 & CN0153 CURRENT SET RESISTOR TABLE**

SERIES	PARALLEL	RESISTOR
3.0A	1.5A	12K
4.0A	2.0A	15K
5.0A	2.5A	27K
6.0A	3.0A	33K
7.0A	3.5A	47K
8.0A	4.0A	68K
9.0A	4.5A	82K
10.0A	5.0A	120K
11.0A	5.5A	180K
12.0A	6.0A	270K
13.0A	6.5A	560K
14.0A	7.0A	3.3M

CAUTION:

Without a current set resistor present, the CN0142/CN0152 and the CN0143/CN0153 default to 3.6 amp and 7.2 amp drive currents respectively. If these current levels are in excess of a motor's rated per phase current, they may damage the motor.

For good low-speed smoothness with the CN0142/CN0143, the motor set current should not vary more than $\pm 20\%$ from the nominal value. This is because accurate microstep spacing occurs over a narrow range of currents. Currents substantially above or below this range may reduce microstep positioning accuracy and increase low speed vibration.

The CURRENT SET terminal has a secondary function. One optional use for the CURRENT SET input is to set a lower standby current while the motor is stopped, or shut off motor current altogether. A standby current can be set by switching another resistor in parallel with the current set resistor. The standby current will be equivalent to the resulting parallel wired resistor. If the current set resistor is shorted out, motor current goes to zero, and the motor is freewheeling.

Fig. 5 shows how an optically isolated standby torque and freewheeling functions may be implemented.

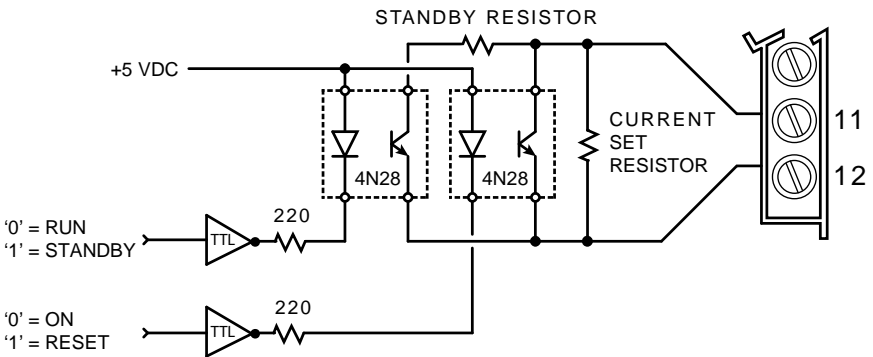

Figure 5

WARNING!

NEVER CONNECT OR DISCONNECT ANY OF THE MOTOR LEADS WITHOUT FIRST DISCONNECTING THE POWER. IF POWER IS NOT TURNED OFF BEFORE ATTACHING OR REMOVING THE MOTOR WIRES, THE DRIVE WILL BE DAMAGED BEYOND REPAIR.

MICROSTEPPING:

Microstepping is a technique that electronically multiplies the number of steps a motor takes per revolution. This is useful because it increases motor angular resolution and decreases motor vibration, in comparison to a full or half step drive like the CN0152 and CN0153. The multiplier is 10 for the CN0142 and CN0143. Thus a 200 step per revolution motor, when driven by this control, will take 2000 steps to complete one revolution.

Microstepping is accomplished by driving the motor windings with sine and cosine weighted currents. A 90 degree electrical angle change in these currents results in a mechanical angle change of 1.8 degrees in a 200 step motor, or one full step.

The number of microsteps per step is determined by the number of sine and cosine values stored for a span of 90 degrees. In the CN0142/CN0143, values are stored for every 9 electrical degrees for a total of 10 for the 90 degree span.

A counter in the CN0142/CN0143 addresses a look-up table that contains pre-calculated sine and cosine values. These values are multiplied by a value proportional to the motor's rated current (determined by the current set resistor). The results are converted to phase currents and applied to the motor.

The STEP input, in conjunction with the DIRECTION input, increments or decrements this counter, which then selects the next look-up table entry.

Low speed vibration results from the start-stop or incremental motion of the motor. This generates periodic acceleration and deceleration reaction torques at the step rate. When the step rate matches, or is a sub-harmonic of the mechanical resonant frequency of the motor, the vibrations become particularly severe.

Microstepping decreases the magnitude of each step ten-fold, with a commensurate decrease in vibration. Vibration is further reduced because at any given speed the microstep rate is 10 times higher than the equivalent full step rate.

One apparent benefit of microstepping is an increase in the number of resolvable angular positions. However, there are a number of factors which limit its achievable open-loop accuracy.

FACTORS AFFECTING MICROSTEP ACCURACY

MOTOR ACCURACY:

Most step motors are specified as having a $\pm 5\%$ non-accumulative step tolerance. This implies that a 200 step per revolution motor will have an absolute accuracy of 1 part out of 2000.

If the motor were run open-loop (as most step motors are) only a ten-fold increase in accurately resolvable locations can be expected. Consequently a 125 microstep drive cannot position a motor any more accurately than a 10 microstep drive, such as the CN0142/CN0143, in an open-loop configuration.

MOTOR LINEARITY:

For every motor there is a function that relates the angle of rotation to the electrical angle of the winding currents. If it were directly proportional, then sine and cosine varying currents would cause a uniform rate of rotation. Alternately this would result in uniformly spaced microsteps.

For most motors this function is 'S' shaped to a greater or lesser degree (fig. 6). The motor current profiles must be distorted from their ideal sine-cosine profiles to compensate for this non-linearity. How well this compensates for the motor's non-linearity will determine the microstep placement accuracy of the control.

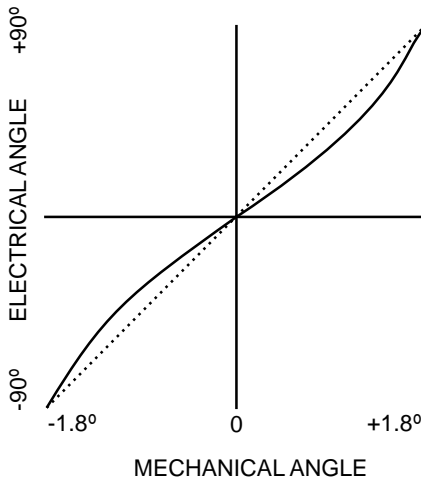

Figure 6

The electrical to mechanical angle function is dependent on motor current. By varying the current set resistor value, it may be possible to trim out any residual positional error. Should this be insufficient, Centent can as an option generate an optimum compensation profile from a sample motor for all motors of a like model number. This custom profile is then 'programmed' into the customer's CN0142/CN0143 controls.

MOTOR LOAD:

A step motor only generates torque when a rotor error angle exists. The relationship between rotor displacement angle and restoring torque for a typical motor is shown in fig. 7.

The function that relates error angle to torque is approximately sinusoidal, so an error angle equal to one microstep occurs with torque load of only 16% of holding torque. Generally speaking, motor load is the single most significant contributor to microstep positioning error. If the load is transient or due to acceleration, the rotor error will decrease to a residual level upon removal of that transient.

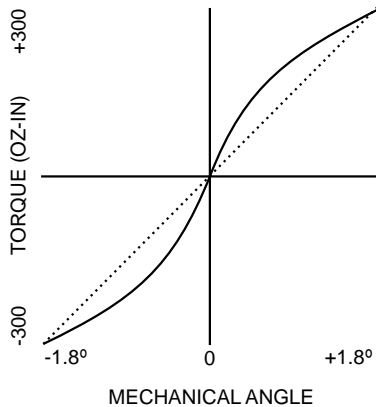

Figure 7

ANTI-RESONANCE CIRCUIT:

Most step motors are prone to parametric instability or resonance when rotating between 4 to 15 revolutions per second. Variously called midband instability, resonance or other terms, it manifests itself as a torsional oscillation of 50 to 150 Hz when the motor is running in this speed range. The torsional oscillation has a tendency to increase in amplitude with time until it reaches a peak equal to the step angle. When this happens, the motor loses synchronization and stops.

Generally the amplitude build-up takes from tens to hundreds of cycles to reach this level, so up to several seconds may elapse from the start of the oscillation until the motor stops. This time is sufficiently long to permit the motor to accelerate through this speed band, however continuous operation in this range is not possible.

Above and below this range of speeds, the oscillation amplitude may not be sufficient to stop the motor but it is still present. Fig. 8 shows the parametric resonance frequency versus motor step rate for three unrelated step motors. In all three cases resonance breaks out at 5 to 7 revolutions per second and is most severe at the higher torsional frequencies (lowest step rates).

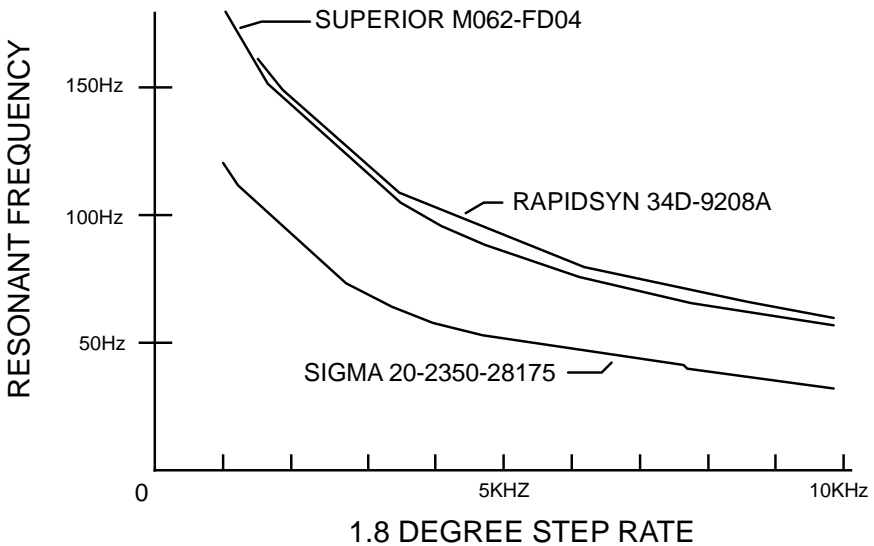

Figure 8

Because any torsional oscillation implies acceleration and deceleration of a mass, torque that otherwise would have been available for useful work is wasted to sustain this oscillation.

Both the CN0142/Cn0143 and the CN0152/CN0153 incorporate a midband anti-resonance compensation circuit that closes the loop on this instability and electronically damps it out. Since the motor is now unable to sustain oscillation, torque previously wasted is now available.

With anti-resonance the motor may be run continuously at speeds where de-synchronization would otherwise occur. The motor no longer exhibits 'forbidden' continuous-operation speed bands and there is more torque available outside these speed ranges as well.

The operation of the anti-resonance circuit in most applications is transparent to the user, in the sense that no special provisions have to be taken to accommodate it. There are three instances where it may be disadvantageous:

1. VERY HIGH SPEED

The anti-resonance circuit limits the maximum speed to 30,000 full steps per second (300,000 pulses per second). Should it be necessary to run the motor faster than that, up to 100,000 full steps per second, a special "anti-resonance disabled" version of the step motor drive can be ordered (a SUPERIOR ELECTRIC ME61-8001 will exceed 100,000 full step per second or 30,000 RPM). On CN0142B/CN0143B versions, connecting pin 7 to pin 1 disables the anti-resonance circuitry.

2. VERY LARGE INERTIAL LOAD

Microstepping permits reliable operation with inertial loads in excess of 100 times the motor's moment of inertia. However a very large inertial load so lowers the mechanical resonant frequency that the anti-resonance circuit may cause oscillation. It may be better to order the drive without the circuit since resonance usually is not a problem with moderate to large inertial loads anyway.

3. IRREGULAR PULSE TRAIN

To operate properly, the anti-resonance circuit cannot tolerate more than a 15% variation in the pulse period at the STEP input. Any variation in excess of this limit may result in missed steps. There are some digital pulse sources that have more than a 15% period to period variation. To use these sources without error the "anti-resonance disabled" version of the step motor drive should be ordered. With CN0142B/CN0143B versions, this can be accomplished by connecting pin 7 to pin 1.

PERFORMANCE CONSIDERATIONS

This section will deal with factors that affect motor performance and the interactions between these factors. This should permit the designer to achieve the optimum balance of performance trade-offs. The factors considered will be:

- TORQUE
- OUTPUT POWER
- POWER SUPPLY VOLTAGE
- SERIES vs. PARALLEL OPERATION
- POWER SUPPLY CURRENT
- MOTOR HEATING
- MOTOR DRIVE HEATING

TORQUE AND POWER vs. SPEED:

Step motor performance curves exhibit two distinct regions with respect to speed. In region 1 (fig. 9), motor torque is constant with speed while motor shaft power is proportional to speed. In region 2, motor torque decreases as the inverse of the speed while motor shaft power remains constant.

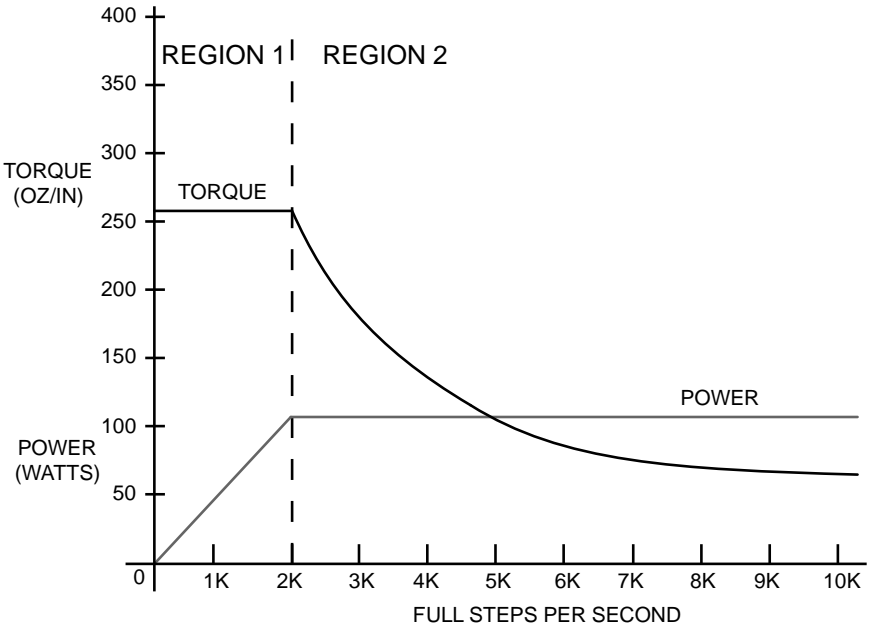

Figure 9

In region 1 the motor torque is held constant by controlling the magnitude of the motor phase current. The step rate in this region is sufficiently low to permit motor current to reach the programmed value.

Above a certain speed, the motor torque begins to drop off as the inverse of the speed. Motor winding inductance limits the rate of current rise, and as speed increases, progressively less current can be forced into the windings. Because motor torque is proportional to phase current, and in region 2 current is proportional to the step period, torque decreases as the inverse of the step rate.

Because power is the product of speed and torque, power remains constant with speed in region 2 in a loss-less step motor.

There are speed related power losses in the motor (i.e. friction, magnetic losses, windage and other losses) that result in a shallow slope to the power curve. Where this slope intersects the speed axis is the maximum speed at which the motor will run.

Caution:

The Centent Drive is capable of running step motors at speeds high enough to cause damage to motor bearings.

FACTORS AFFECTING POWER AND TORQUE

POWER SUPPLY VOLTAGE:

The choice of power supply voltage affects the power a step motor generates in region 2. The speed to which constant torque is maintained is proportional to power supply voltage. Consequently maximum motor shaft power is also proportional to the power supply voltage.

The step motor drive has a power supply range from 24 to 60 VDC. This results in a motor power range of 2.5:1.

Increasing power supply voltage increases motor heating. Taking this into consideration, the choice of power supply voltage should be just high enough to meet the application's power requirements and no higher.

SERIES vs. PARALLEL OPERATION:

The customer has the option of wiring 6 and 8 wire motors in either series or parallel configuration.

Parallel operation doubles the maximum motor power output over what can be obtained with series operation. The speed to which constant torque is maintained is also doubled. This performance improvement comes at the expense of greater motor and control heating.

Series operation is preferred for low speed (region 1) operation, and suitable in region 2 if the available power is sufficient. Series operation benefits are low motor and control heating and modest power supply current requirements.

Using the power supply voltage range in conjunction with either series or parallel operation permits a 5:1 range in maximum motor power.

Fig. 10 illustrates the effects of series vs. parallel operation at low and high power supply voltages on motor performance. Note that series operation at 54 VDC supply voltage yields performance virtually identical to parallel operation at 27 VDC supply voltage.

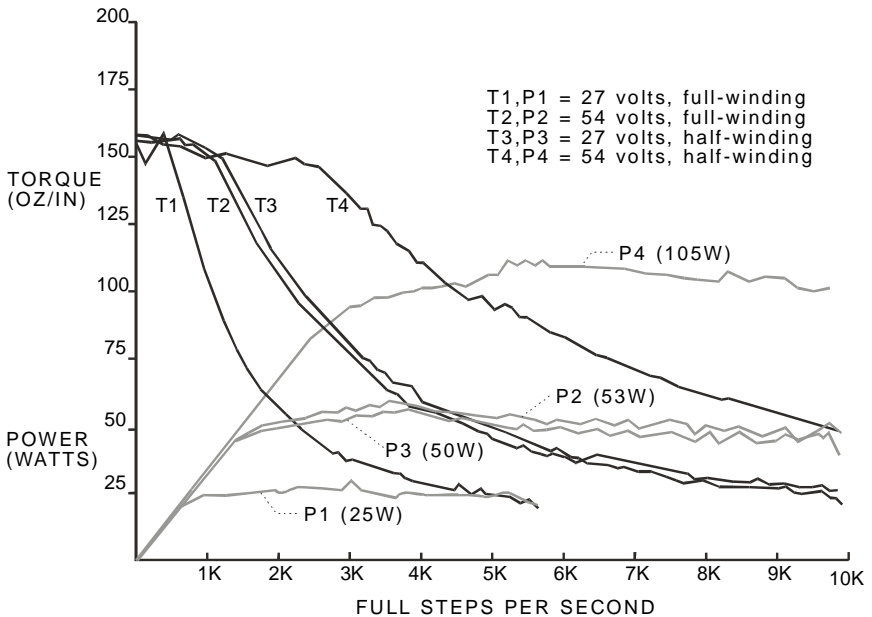

Figure 10

TORQUE:

The current set resistor determines the motor torque in region 1. Motor torque is approximately proportional to motor current times the number of winding turns that carry the current. In series operation, twice the number of turns carry current as do in parallel operation, so only half the current is needed to generate a given level of torque.

Unfortunately series operation quadruples the effective winding inductance. In region 2, motor power is proportional to the inverse of the square root of the winding inductance.

Fig. 11 illustrates the effect of various winding currents on motor performance. A 4 Amp per phase motor was driven from 1 to 6 Amps per phase in 1 Amp increments.

In region 1 motor torque is nearly proportional to motor current. Torque remains constant until it intersects the motor's load line, which may be approximated as:

$$T = kV / f L$$

T = torque
k = motor constant
f = steps per second
L = motor inductance
V = power supply voltage

The intersection of the constant torque line and the motor load line marks the beginning of region 2. Above this speed motor torque is not dependent on the current set resistor.

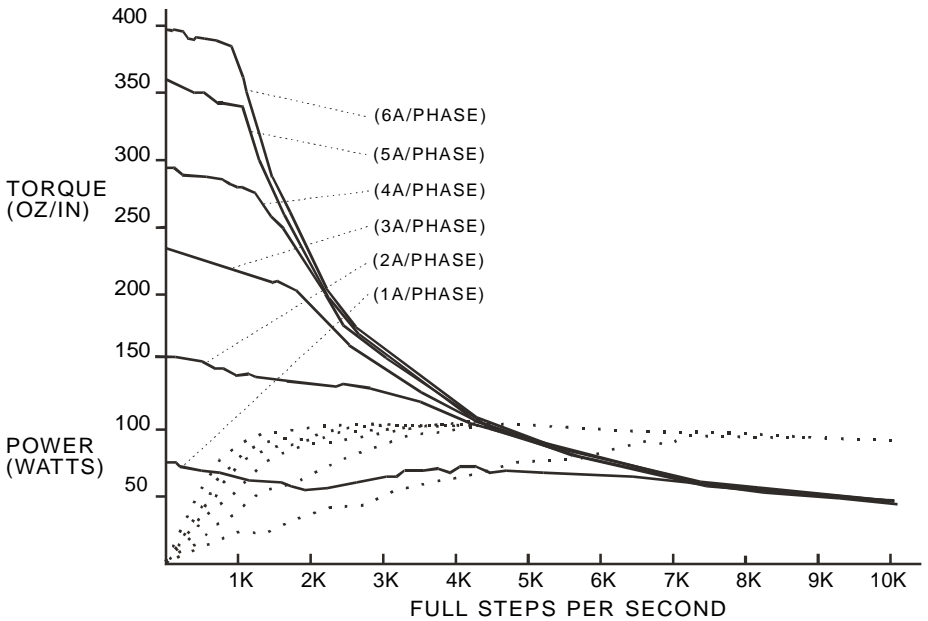

SUPERIOR ELECTRIC M092-FD08
4A 3V

Figure 11

Note that if the motor in fig. 11 is operated in excess of 4000 steps/sec. it would make no performance difference what the current set was. What would be significant would be the greatly reduced motor and control heating at low speed at the lower current setting.

POWER SUPPLY CURRENT:

Power supply current depends on the current set resistor value, the speed the motor is running and the load applied to the motor.

Generally speaking, the power supply current for a 6 wire motor in the series configuration will not exceed 1/3 the motor's rated per phase current. A parallel configured motor will require no more than 2/3 the rated per phase current.

Fig. 12 is representative of a parallel configured motor's power supply current requirements vs. speed. The solid curve is for an unloaded motor while the dotted curve is for a fully loaded motor.

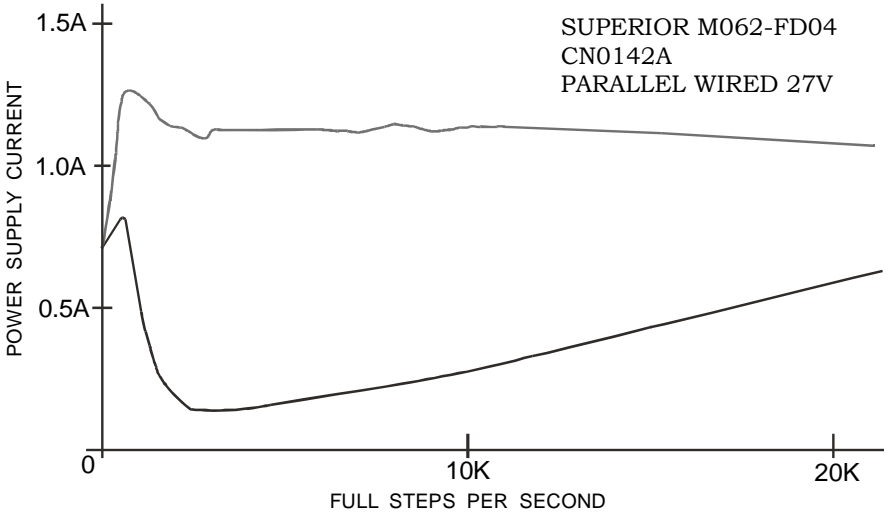

Figure 12

MOTOR AND CONTROL HEATING:

Motor and control heating is equivalent to the difference between the electrical power input and the motor's mechanical power output. The ratio of the power out vs. power in is the system efficiency.

The power losses are dependent on motor speed, load and winding configuration, the power supply voltage, current set and other factors.

The power losses in the step motor drive are primarily resistive and therefore relatively easy to calculate. Each channel of the drive may be considered to be equivalent to a .55 ohm resistor.

WARNING!

THE DRIVE MUST HAVE SUFFICIENT HEAT SINKING TO KEEP THE CASE TEMPERATURE BELOW +70 DEGREES C (+158 DEGREES F) OR PERMANENT DAMAGE WILL RESULT.

Step motor drive dissipation in region 1 is always considerably higher than in region 2. In region 1, motor phase currents, and therefore drive channel currents are sinusoidal. The peak amplitude is equal to the rated per phase current in the parallel mode and half of that in the series mode. In region 1, power dissipation is approximately:

$$\begin{aligned} W &= .55 (I\phi)^2 && \text{for parallel wired motors} \\ W &= .55 (I\phi/2)^2 && \text{for series wired motors} \end{aligned}$$

Note that the power dissipation is 4 times higher for the parallel connection.

In region 2 power dissipation can be calculated as:

$$\begin{aligned} W &= 1.1 (I\phi/3)^2 && \text{for parallel wired motors} \\ W &= 1.1 (I\phi/6)^2 && \text{for series wired motors} \end{aligned}$$

Region 1 power dissipation is 4.5 times greater than region 2 power dissipation. If the motor will spend most of its time stopped or in region 1, use region 1 power dissipation equations to evaluate the needs for heat sinking. Alternately, consider reducing motor set current while the motor is stopped to reduce power dissipation. As a practical guide, heat sinking will almost certainly be required if the drive is set to 3 amps or more. Generally, if the unit is too hot to touch, it needs additional cooling. The case temperature should never under any circumstance, be allowed to exceed +70 degrees C (+158 degrees F), since this will destroy the drive.

MOTOR SPEED-TORQUE & SPEED-POWER CURVES:

The following pages contain motor speed-torque and speed-power curves. Two sets of curves are plotted per motor using the CN0143. One set was taken at 54 VDC power supply voltage, the other at 27 VDC. The dynamometer moment of inertia was adjusted to be equivalent to the motor's moment of inertia. The test data was collected at 100 points between zero and 10,000 full steps per second.

The motors were operated in the parallel configuration for both test runs. The lower voltage test run is representative of a series configured motor run at 54 VDC supply voltage. A power supply voltage between the two test run voltages would yield results between the plotted results. The dotted power output curve is the mechanical power output of the motor, measured in watts.

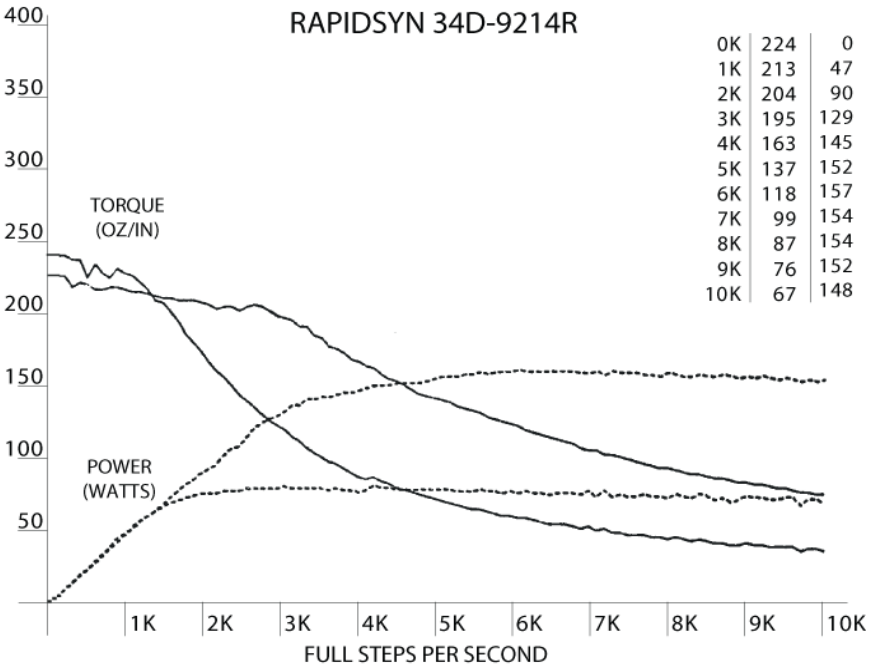
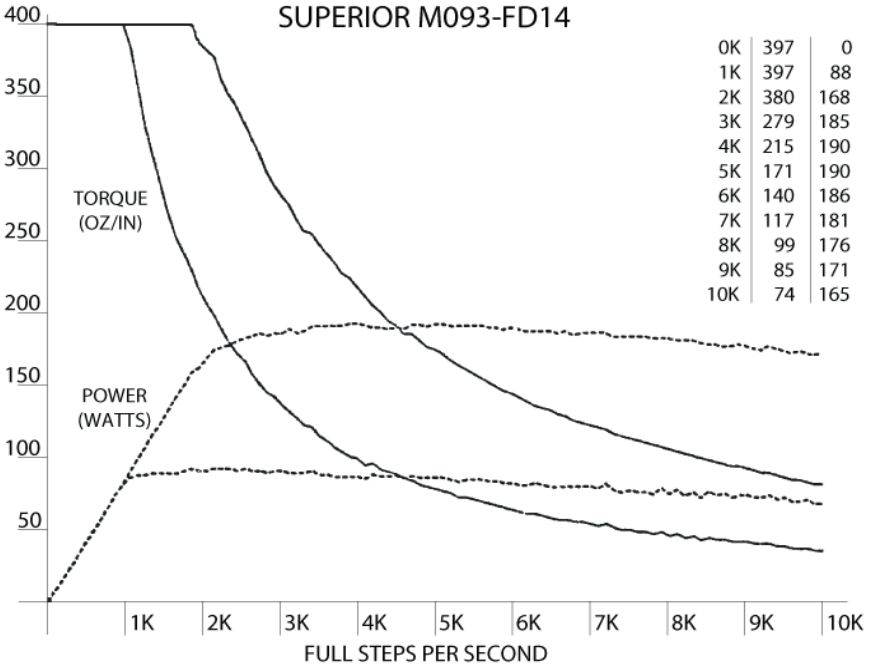

WARNER SM-200-0125-BC

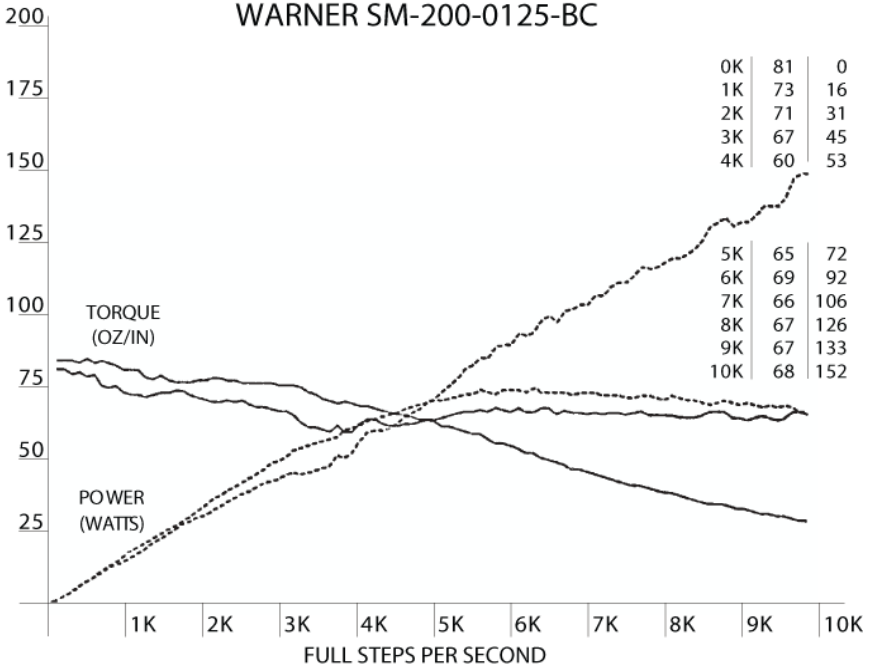

MAE MY200-2240-460A8

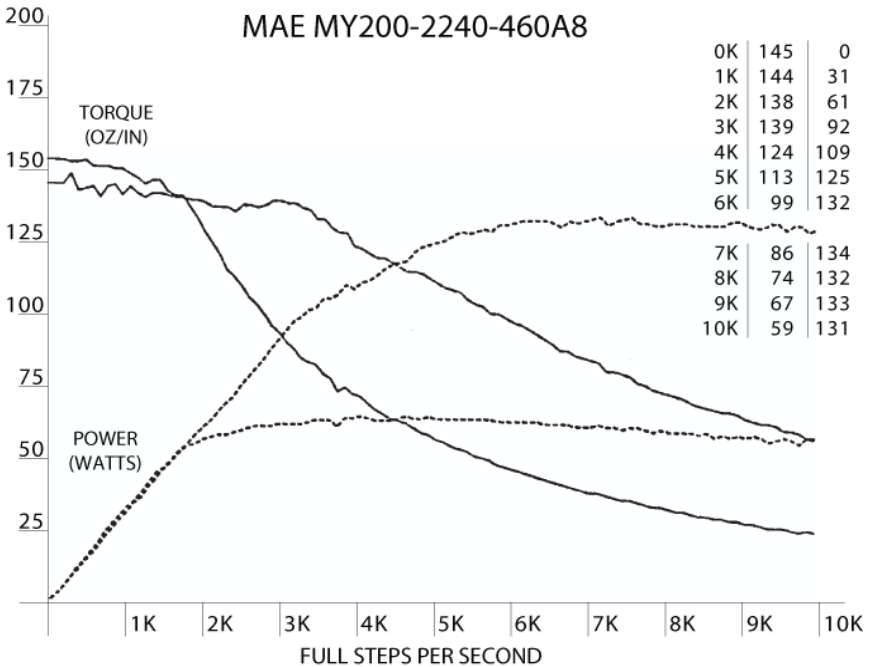

MAE MY200-3437-400A8

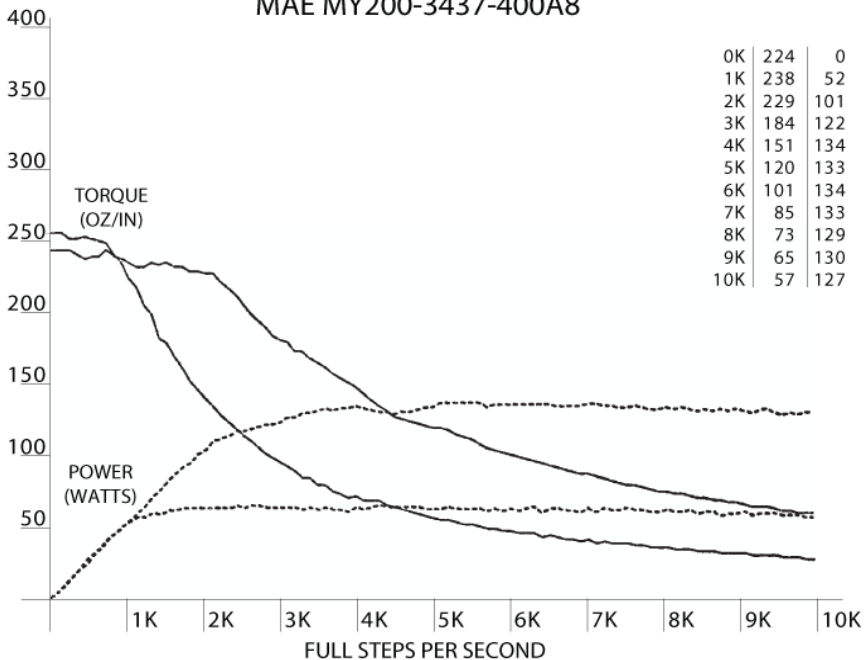

SUPERIOR M093-FD11

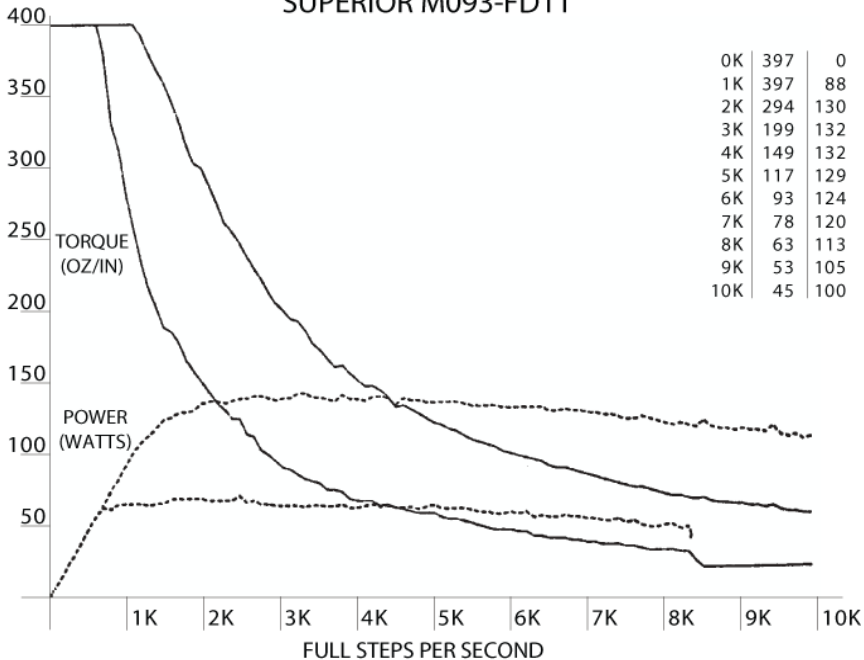

BODINE 34T3 2005

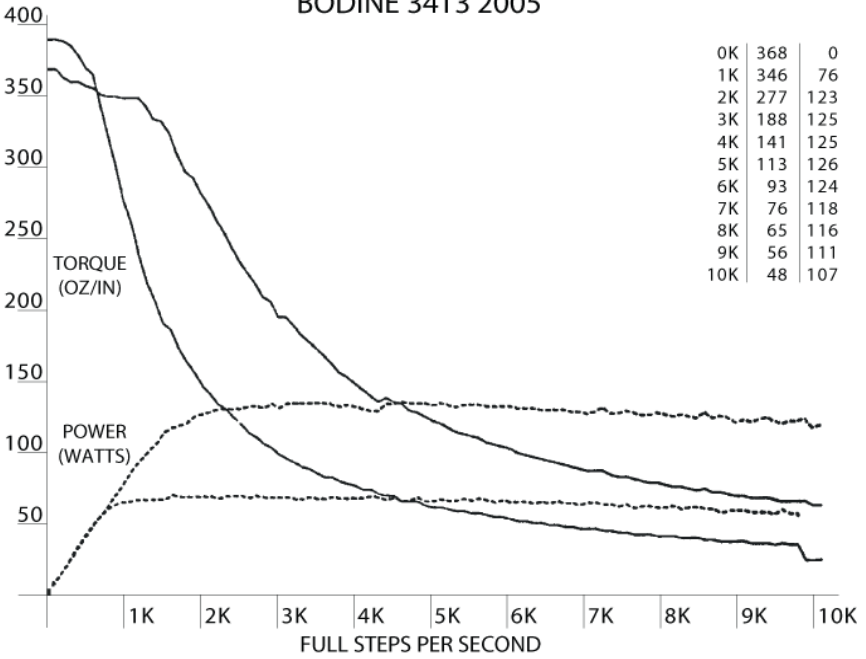

JAPAN SERVO KP88M2-001

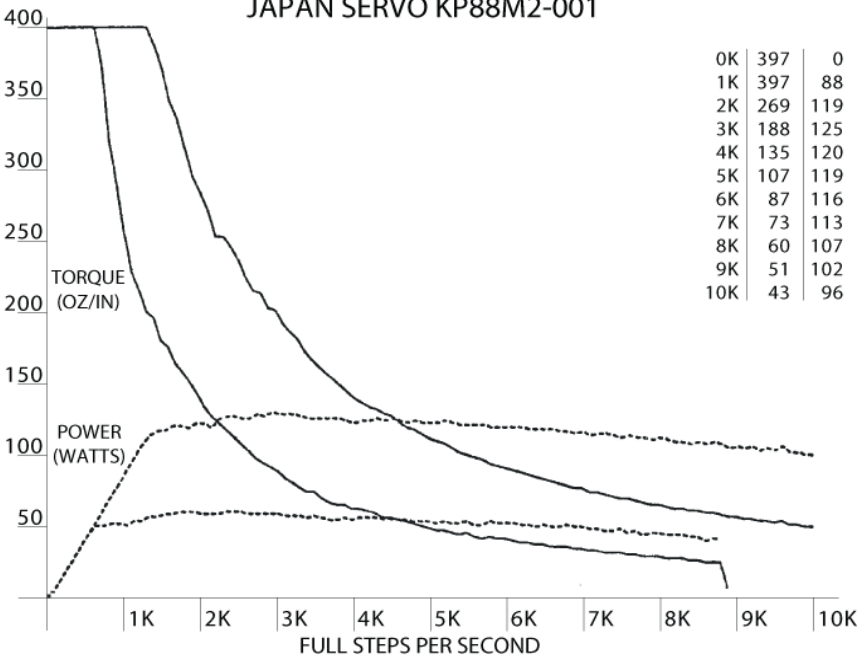

RAPIDSYN 34D-9206A

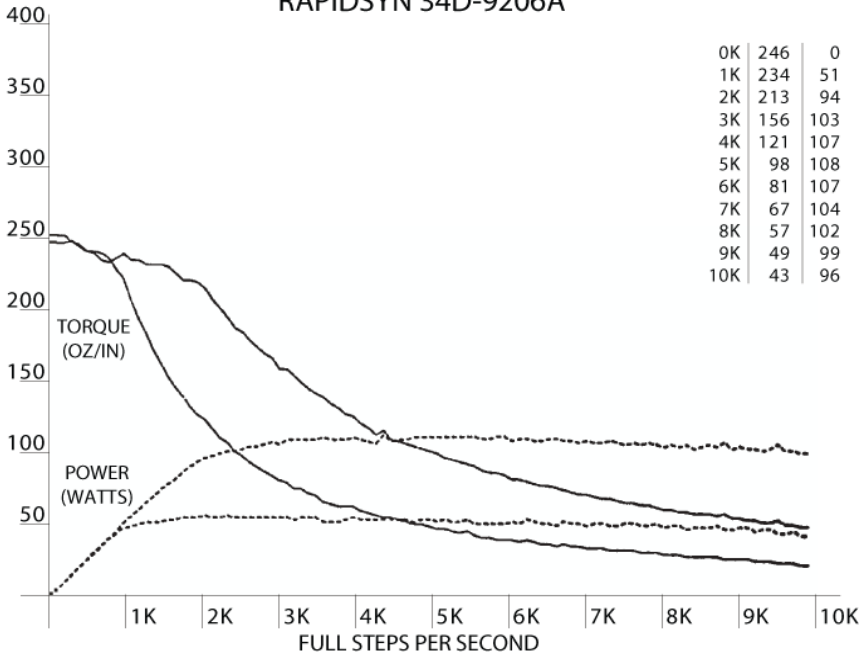

VEXTA PH265-05

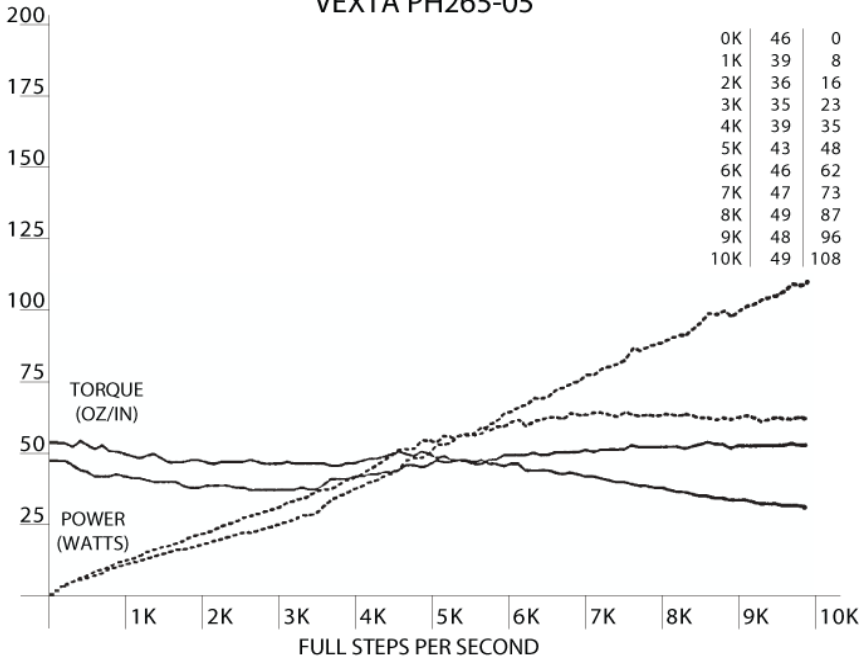

VEXTA PH296-01

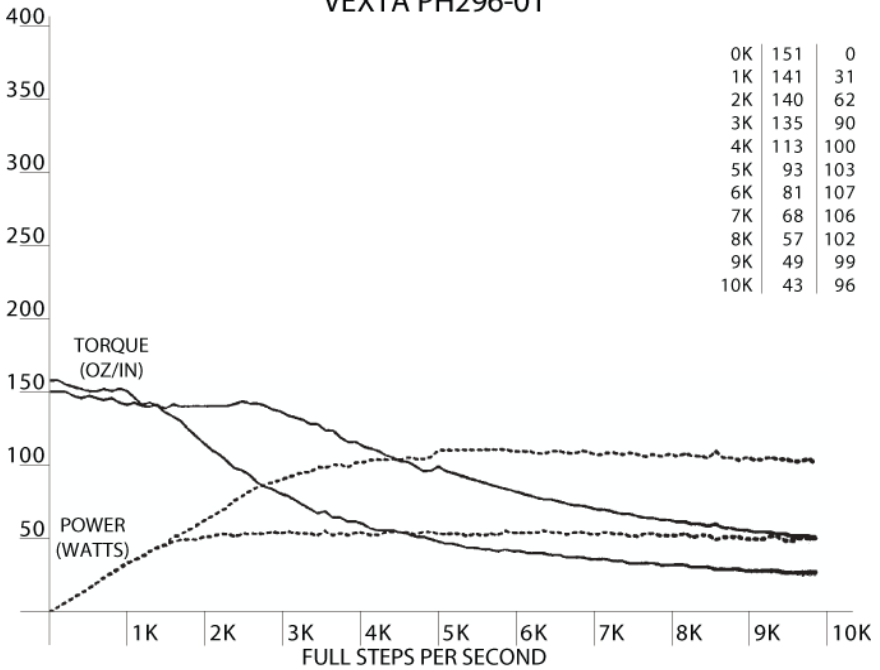

BODINE 34T2 2104

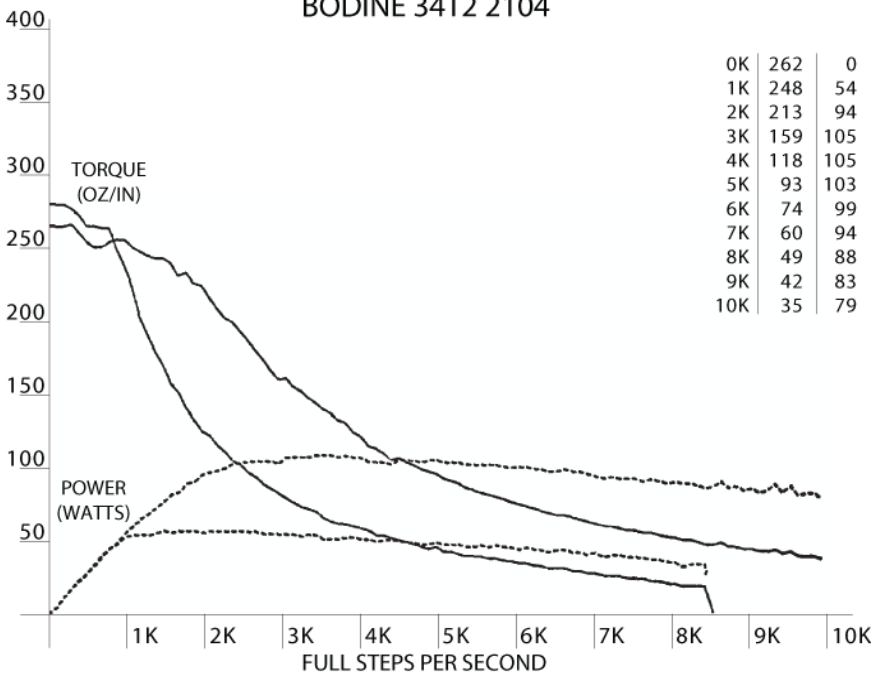

SUPERIOR M092-FD08

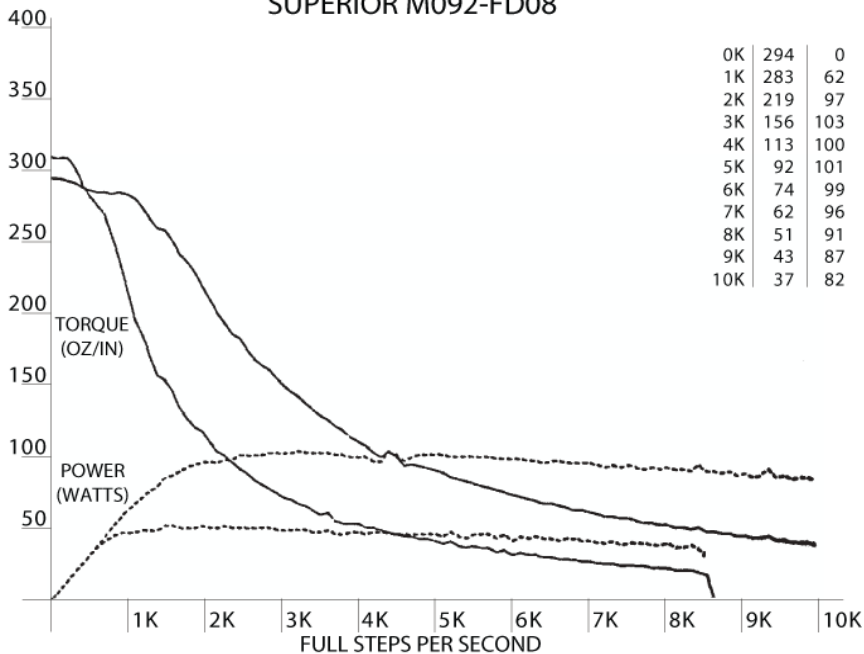

SUPERIOR ME61FD-80083

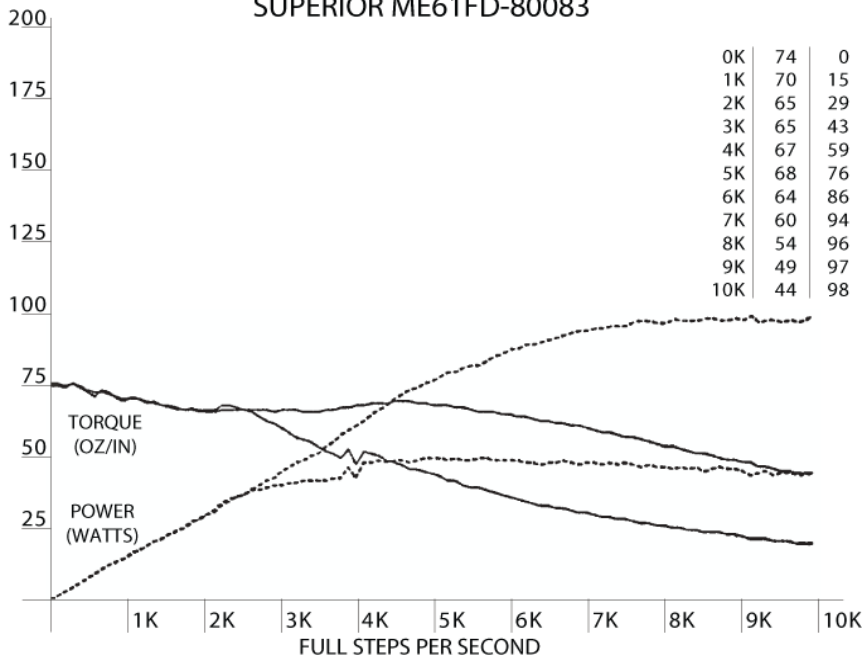

JAPAN SERVO KPM8AM2-001

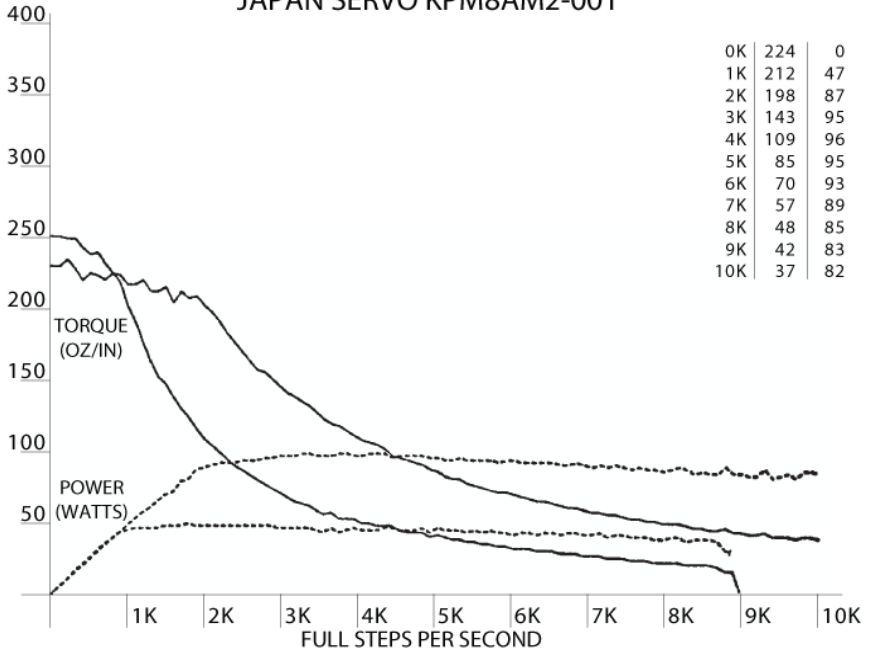

VEXTA PH268-05

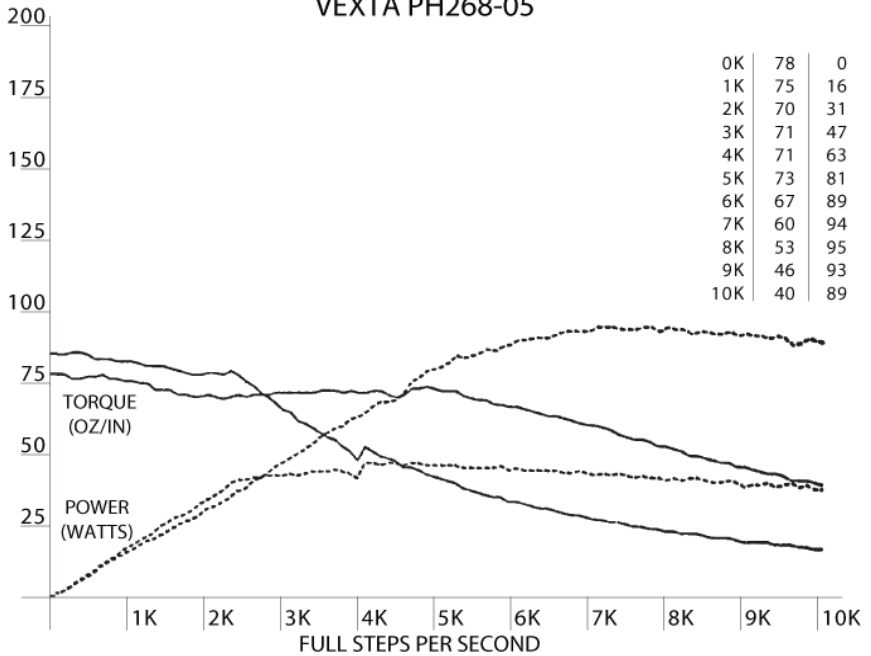

SUPERIOR M091-FD09

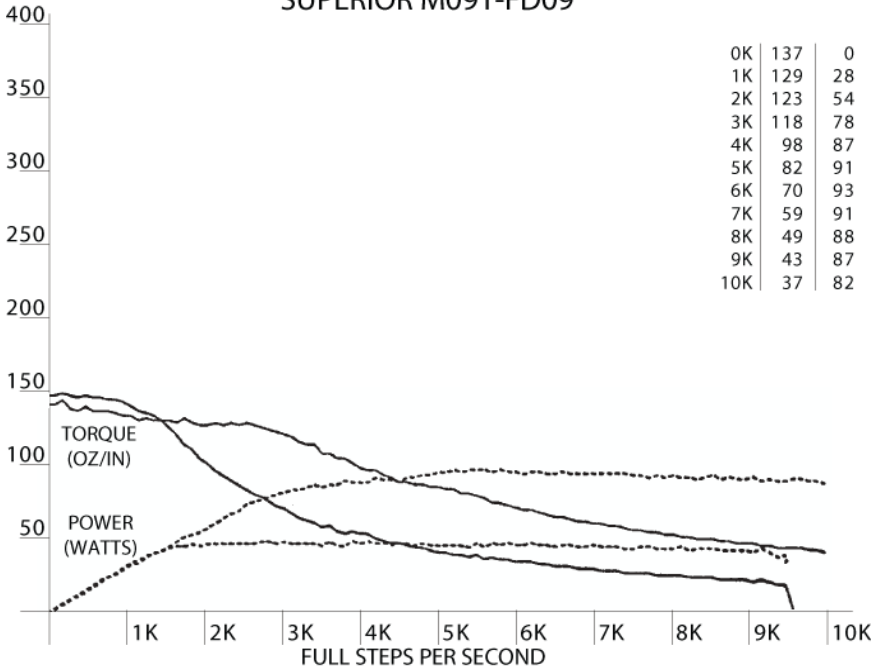

SUPERIOR M061-FD08

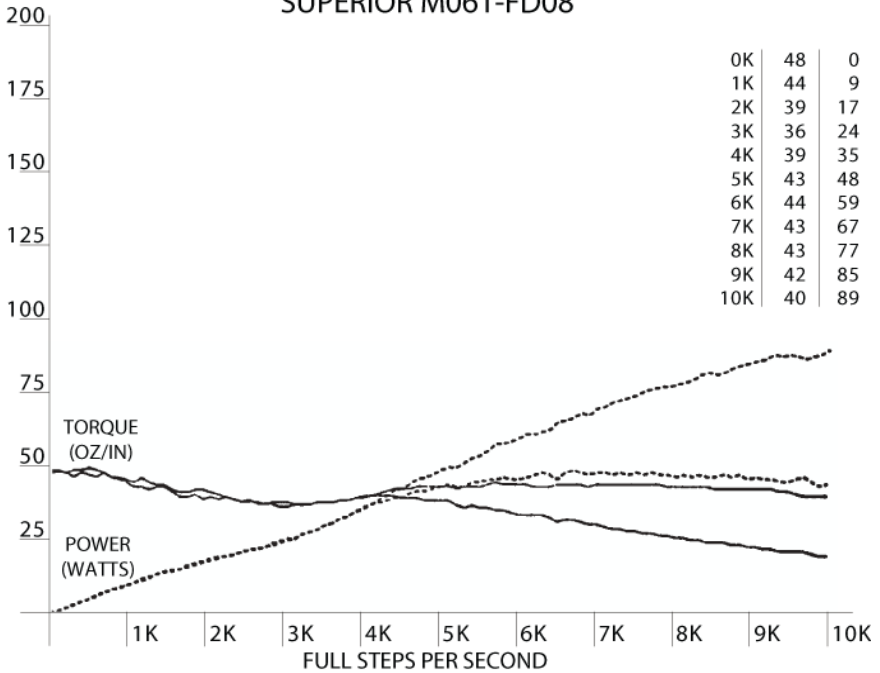

RAPIDSYN 23D-6306

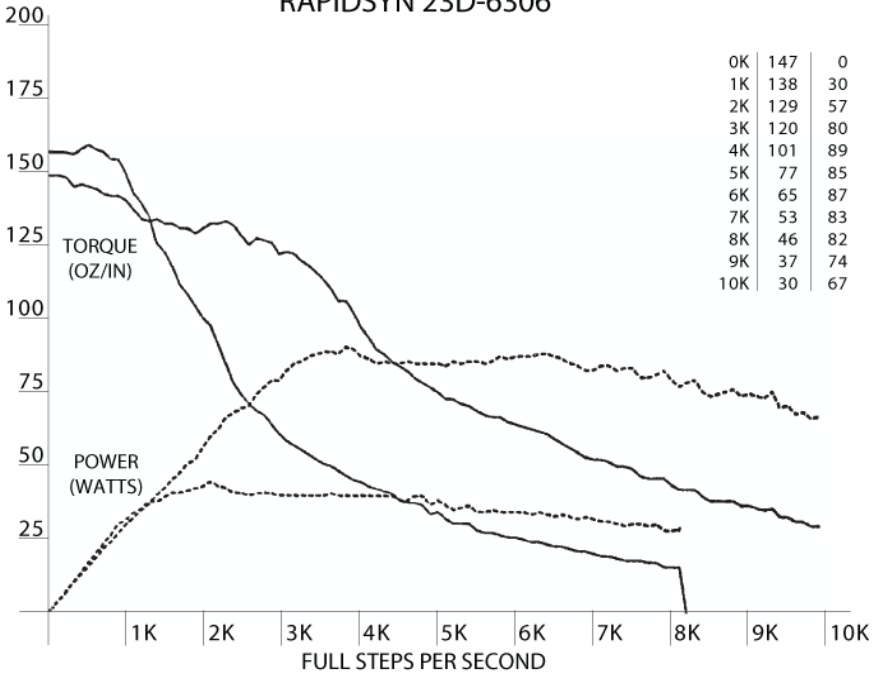

RAPIDSYN 34-9601A

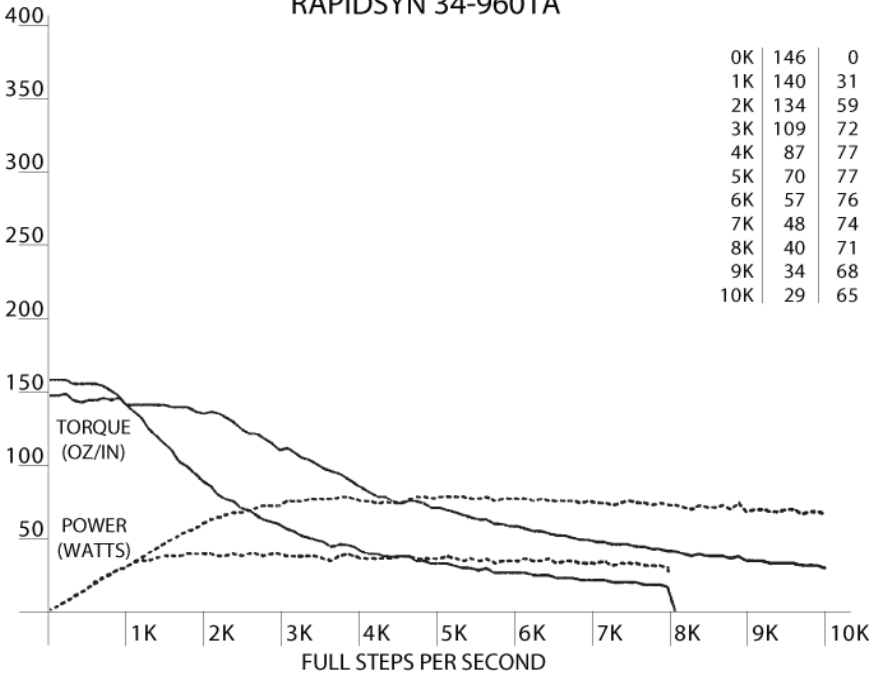

SUPERIOR M091-FD-6006

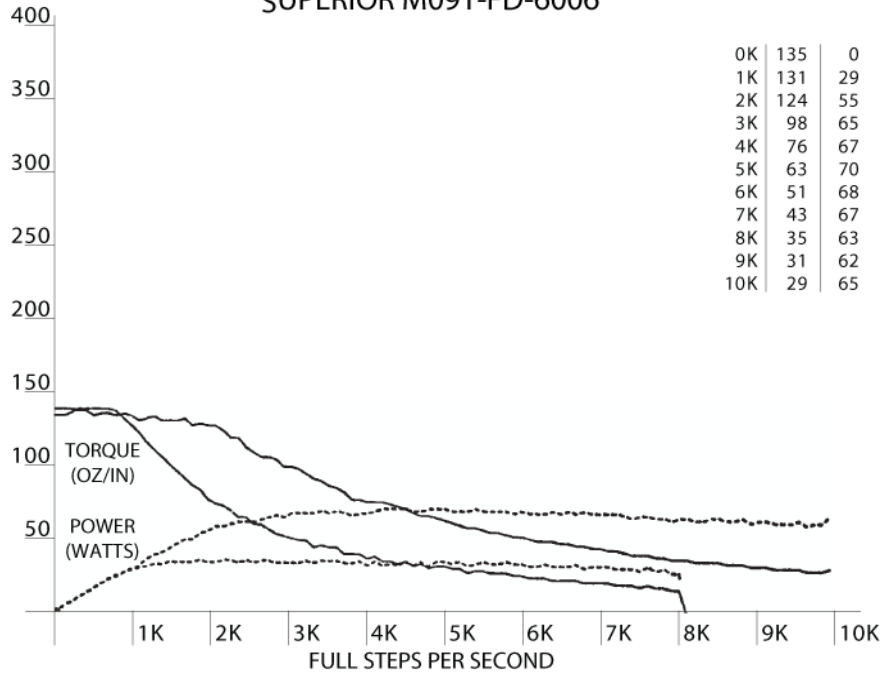

VEXTA PH299-01

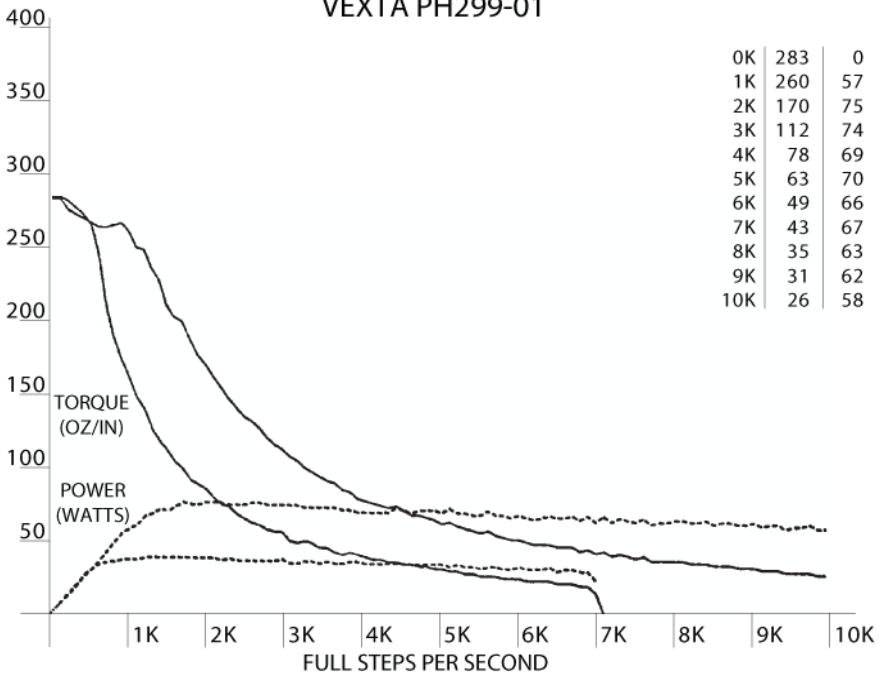

RAPIDSYN 23D-6204

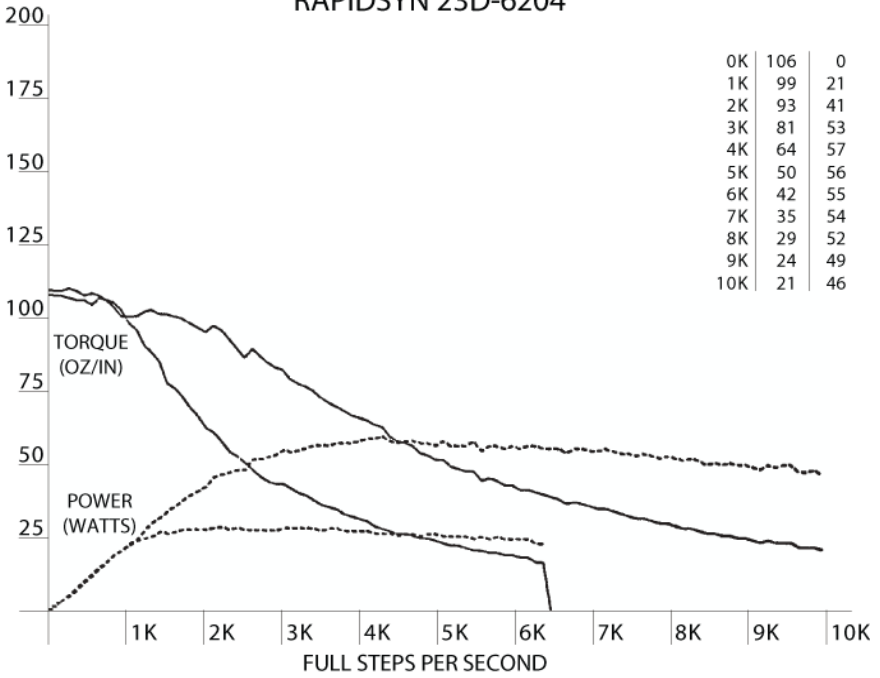

SUPERIOR M062-FD04

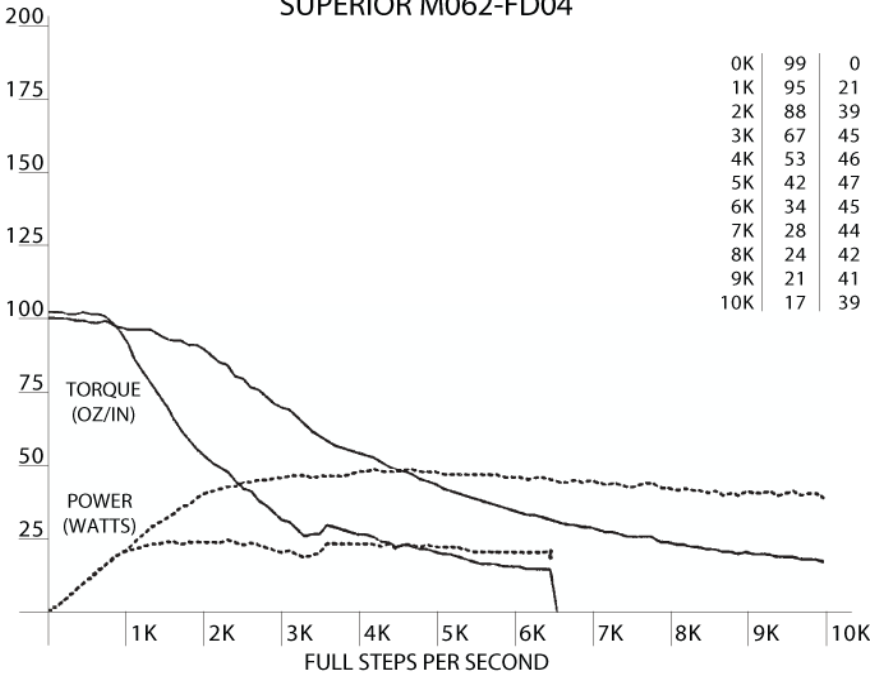

WARNER SM-200-0080-B8

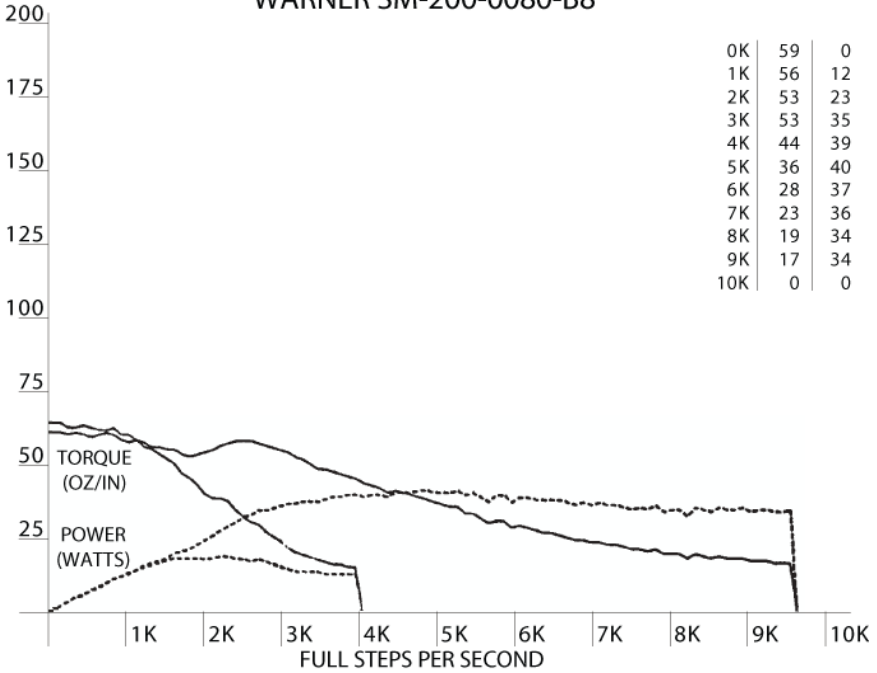

SUPERIOR M091-FD03

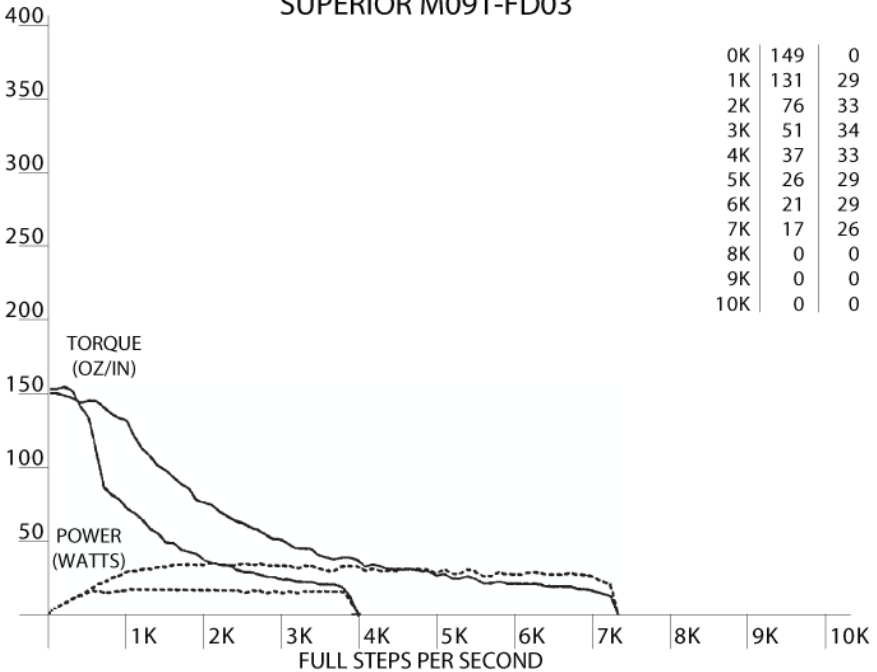

RAPIDSYN 23D-6102

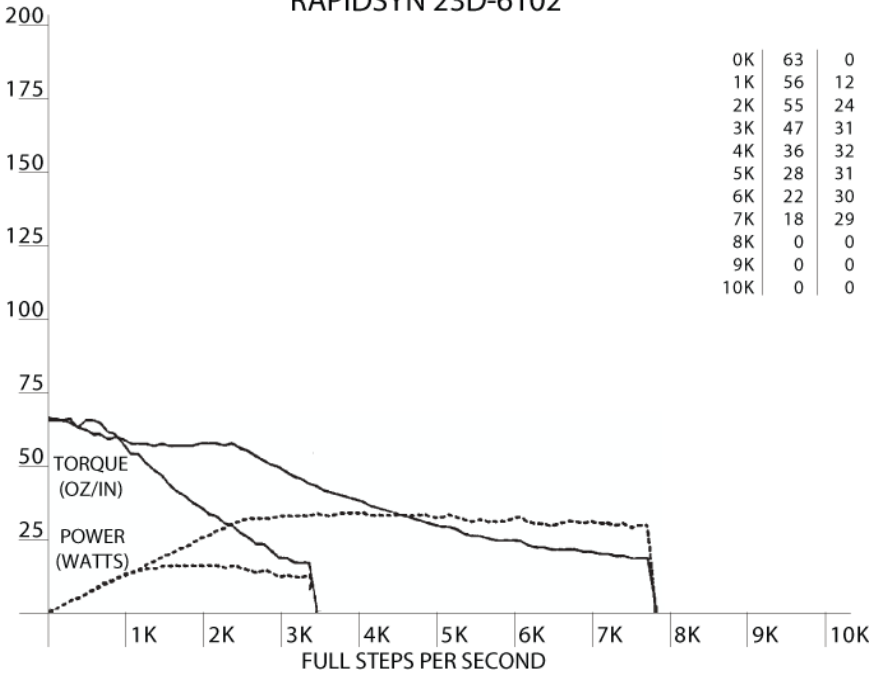

SUPERIOR M061-FD02

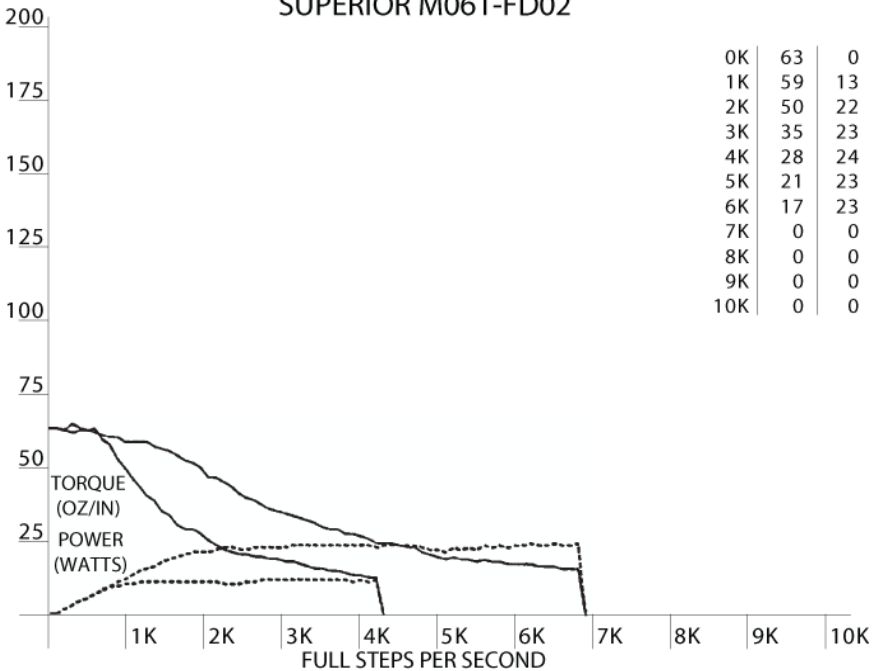

SPECIFICATIONS

PARAMETER	MIN	MAX	UNITS
ELECTRICAL:			
GENERAL			
Resolution			
CN0142 & CN0143	.1	.1	Full-step
CN0152 & CN0153	.5	1	Full-step
Supply voltage	24	60	VDC
Current (no motor)	50	60	mA
PWM frequency	18	24	kHz
Motor current			
CN0142	.75	3.5	ampere
CN0143	1.5	7.0	ampere
CN0152	.25	3.5	ampere
CN0153	.50	7.0	ampere
Motor Inductance	1		mH
STEP PULSE INPUT			
Voltage	0	+5.0	VDC
Input impedance	12	20	mA
Pulse 'high'	1	---	μSEC
Pulse 'low'	1	---	μSEC
Rise time	---	.5	μSEC
Fall time	---	.5	μSEC
Frequency	---	500	KHz
Logic '1' volts	+1.8	+2.0	VDC
DIRECTION INPUT			
Voltage	0	+5.0	VDC
Current	12	20	mA
Logic '1' volts	+1.8	+2.0	VDC
ENVIRONMENTAL:			
Operating temp.	-20	+70	C
Humidity	0	100	%
Shock	---	150	G
Dust, oil, etc.	---- NO LIMIT ----		
MECHANICAL:			
Weight	19	20	OZ
Size	8h x 4w x 4.5d		inches
Mounting hole centers	3.625 x 3.625		inches
Mounting screw size	#6	#8	
Terminal Screw Torque		4.5	lb/in